

NARDI

COMPRESSORI

MEDICAL

Quality system certified
to ISO 9001:2015



MEDICAL COMPRESSORS

Catalogue



(ENG) NARDI COMPRESSORI was founded in 1965 by the Ghiotto family in Montecchio Maggiore (Vicenza). The symbol indicates the union of the two names Nardi and Ghiotto owners of the company and leaders in the design and construction of high-tech compressors. In 2008 ongoing investments to improve production processes led to the purchase of a facility of 7000 m² with modern and efficient departments. In 2010, the company was certified UNI EN ISO 9001:2015 with the certifying body TÜV which is among the most qualified in the world. Always careful about production and technology, NARDI COMPRESSORI is proud of having a fully ITALIAN production with testing of each product individually. Today NARDI COMPRESSORI is known in

over 100 countries around the world with a range of compressors from 8 bar up to over 500 bar and a production of over 30,000 units produced each year.

(ITA) NARDI COMPRESSORI è stata fondata nel 1965 dalla famiglia Ghiotto a Montecchio Maggiore (VI). Il simbolo indica l'unione dei due nomi NARDI e GHIOTTO titolari della azienda, leader nella progettazione e costruzione di compressori ad alto contenuto tecnologico. I continui investimenti atti a migliorare i processi produttivi hanno portato nel 2008 all'acquisto dello stabilimento di 7000 m³ con reparti efficienti e moderni. Nel 2010 l'azienda si è certificata UNI EN ISO 9001:2015 con l'ente certificante TÜV fra i più qualificati al mondo. Sempre attenta alla produzione e alla tecnologia, la NARDI COMPRESSORI vanta di una produzione completamente ITALIANA con collaudi di ogni singolo articolo. Oggi è apprezzata in più di 100 paesi in tutto il mondo con una gamma di compressori che va dai 8 bar fino a oltre i 500 bar e una produzione che supera i 30.000 pezzi prodotti ogni anno.



MEDICAL COMPRESSOR



(ENG) Nardi Compressori S.r.l. has designed and developed a full line of compressors for Dental Industry as a complement to a very wide range of products that covers various market niches. Its internal organization and its dynamic structure allows Nardi Compressori to respond swiftly to market trends and meet customer requirements.

Nardi's Dental compressors are designed and manufactured in-house by our expert technicians with many years of experience in this sector.

Today Nardi Compressori is able to produce oil free Dental compressors which are modern, strong and silent. Dental compressors tanks are painted inside with epoxy electrostatic powder paint to avoid corrosion.

All compressors are equipped with efficient filtering system that absorbs humidity and dries the air. The filter are made with silica gel that guarantees the air will remain moisture free.



(ITA) La ditta Nardi Compressori S.r.l. ha progettato e sviluppato una linea di compressori dentali a completamento di una vasta gamma di prodotti che coprono diverse nicchie di mercato.

L'organizzazione interna e la struttura dinamica della ditta, le consentono di rispondere velocemente e tempestivamente alle esigenze del mercato ed alle necessità dei clienti.

I compressori dentali sono progettati e prodotti direttamente e totalmente in fabbrica da esperti tecnici che

vantano molti anni di esperienza nel settore.

Oggi Nardi Compressori è in grado di produrre compressori

dentali moderni, resistenti e silenziosi.

I serbatoi dei compressori sono tutti verniciati internamente con polvere epossidica allo scopo di evitarne la corrosione.

Tutti i compressori hanno un efficiente sistema di filtraggio che assorbe l'umidità. Il filtro è costituito da gel di silicio che garantisce all'aria di rimanere secca ed inodore.

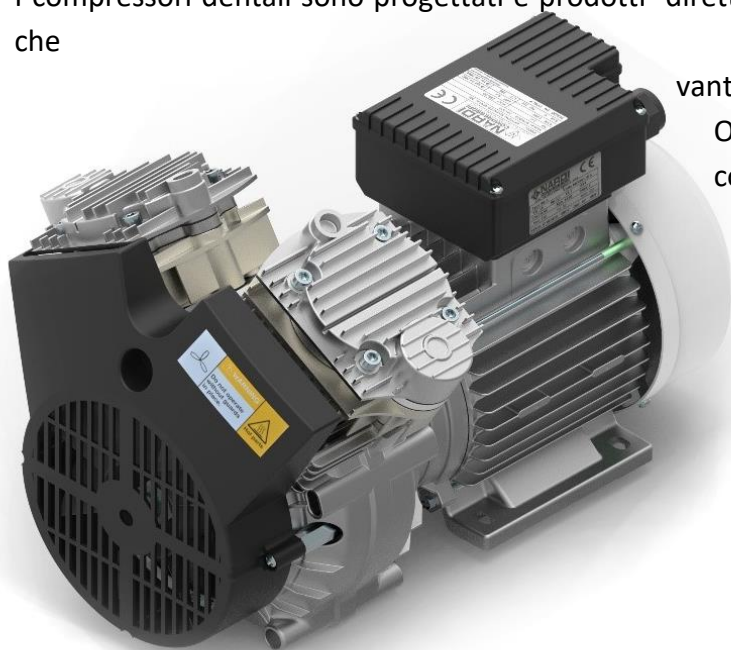

Packing Imballo

Weight with box (ESPRIT 60) : 26 Kg - 57,3 Lbs
 Box dimensions cm : 49 x 49 x 72 (0,017m³)
 Quantity per PALLET (110x110) : 8 pc.



 Dental unit	Pneumatic		
	Electric-Pneumatic		
	Electric		
ESPRIT 60/4	1	X	X
ESPRIT 65/4	1	X	X
ESPRIT 60/2	1	X	X
ESPRIT 65/2	1	1	X

Compressor Model	Tank	Dryer	Cylinders	Air Intake	Air delivery	Pressure	Power	Phase	Revolution	Noise	Weight	Dimensions
Modello Compresore	Serb.	Essicat.	Cilindri	Aria Aspirata	Aria resa	Pressione	Motore	Fase	Giri	Rumore	Peso	Dimensioni
Type	Liters	Complete	N°	l/min. - C.F.M.	l/min. - C.F.M.	Bar - Psi	HP - kW	Tippe	Rpm	dB	Kg - Lbs	cm (LxWxH)
ESPRIT 2V 60/4 25L	25	X	2	105 - 3,7	40 - 1,4 (5 BAR) 20 - 0,7 (8 BAR)	8 - 114	0,75 - 0,5	Single	1400	52	23 - 51	41 x 45 x 52
ESPRIT 2V 65/4 25L	25	X	2	125 - 4,4	56 - 2,0 (5 BAR) 38 - 1,3 (8 BAR)	8 - 114	0,9 - 0,65	Single	1400	53	23,5 - 52	41 x 45 x 52
ESPRIT 2V 60/2 25L	25	X	2	210 - 7,4	75 - 2,6 (5 BAR) 50 - 1,8 (8 BAR)	8 - 114	0,75 - 0,5	Single	2800	62	23 - 51	41 x 45 x 52
ESPRIT 2V 65/2 25L	25	X	2	250 - 8,8	84 - 3,0 (5 BAR) 63 - 2,2 (8 BAR)	8 - 114	0,9 - 0,65	Single	2800	63	23,5 - 52	41 x 45 x 52

With automatic thermal protection

Con protezione termica automatica

EXTREME 2D 25 Liters

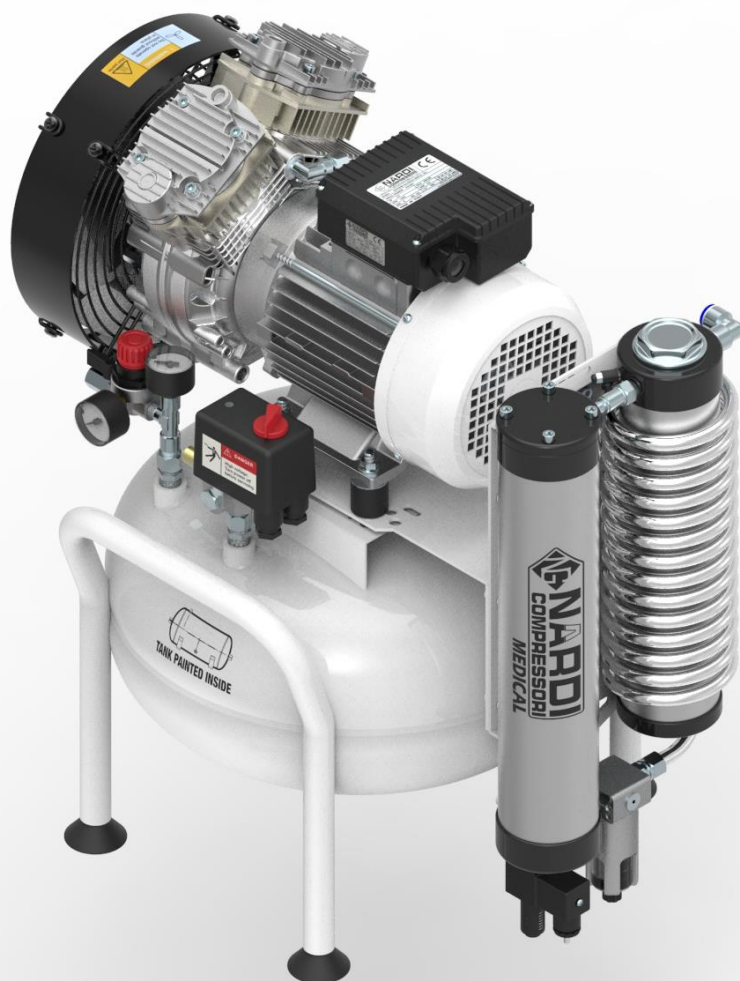

Packing

Imballo

Weight with box (EXTREME 2D 1,5HP) :

44 Kg - 97 Lbs

Box dimensions cm : 58,5 x 57,5 x 66 (0,20m³)

Quantity per (110x110) PALLET : 8 pc.

Dental unit 	Pneumatic		
	Electric-Pneumatic		
	Electric		
EXTREME 0,75	1	X	X
EXTREME 1,50	2	1	1
EXTREME 2,00	2	2	1

Compressor Model	Tank	Dryer	Cylinders	Air Intake	Air delivery	Pressure	Power	Phase	Noise	Weight	Dimensions
Modello Compressore	Serb.	Essicat.	Cilindri	Aria Aspirata	Aria resa	Pressione	Motore	Fase	Rumore	Peso	Dimensioni
Type	Liters	Complete	N°	l/min. - C.F.M.	l/min. - C.F.M.	Bar - Psi	HP - kW	Tippe	dB	Kg - Lbs	cm (LxWxH)
EXTREME 2V 25L 0,75	25	X	2	200 - 7,0	60 - 2,1 (5 BAR) 42 - 1,5 (8 BAR)	8 - 114	0,75 - 0,5	Single	72	30,5 - 67	46 x 43 x 66
EXTREME 2D 25L 0,75	25	✓	2	200 - 7,0	60 - 2,1 (5 BAR) 42 - 1,5 (8 BAR)	8 - 114	0,75 - 0,5	Single	72	38,5 - 85	58,5 x 43 x 66
EXTREME 2V 25L 1,50	25	X	2	240 - 8,5	125 - 4,4 (5 BAR) 100 - 3,5 (8 BAR)	8 - 114	1,50 - 1,1	Single	72	33 - 73	46 x 43 x 66
EXTREME 2D 25L 1,50	25	✓	2	240 - 8,5	125 - 4,4 (5 BAR) 100 - 3,5 (8 BAR)	8 - 114	1,50 - 1,1	Single	72	41 - 90,5	58,5 x 43 x 66
EXTREME 2V 25L 2,00	25	X	2	350 - 12,4	156 - 5,5 (5 BAR) 127 - 4,5 (8 BAR)	8 - 114	2,00 - 1,5	Single	73	35,5 - 78	46 x 43 x 66
EXTREME 2D 25L 2,00	25	✓	2	350 - 12,4	156 - 5,5 (5 BAR) 127 - 4,5 (8 BAR)	8 - 114	2,00 - 1,5	Single	73	44 - 97	58,5 x 43 x 66

With automatic thermal protection

Con protezione termica automatica

MADE IN ITALY BY NARDI COMPRESSORI

Page 05



Packing Imballo

Weight with box (EXTREME 2D 1,5HP) :

51 Kg - 112,4 Lbs

Box dimensions cm : 60 x 45 x 86 (0,23 m³)

Quantity per (110x110) PALLET : 8 pc.

 Dental unit	Pneumatic		
	Electric-Pneumatic		
	Electric		
EXTREME 0,75 CV	1	X	X
EXTREME 1,50 CV	2	1	1
EXTREME 2,00 CV	2	2	1
EXTREME 2,50 CV	4	3	2
EXTREME 3,00 CV	6	4	3

Compressor Model	Tank	Dryer	Cylinders	Air Intake	Air delivery	Pressure	Power	Phase	Noise	Weight	Dimensions
Modello Compressore	Serb.	Essicat.	Cilindri	Aria Aspirata	Aria resa	Pressione	Motore	Fase	Rumore	Peso	Dimensioni
Type	Liters	Complete	N°	l/min. - C.F.M.	l/min. - C.F.M.	Bar - Psi	HP - kW	Tip	dB	Kg - Lbs	cm (LxWxH)
EXTREME 2V 50L 0,75	50	X	2	200 - 7,0	60 - 2,1 (5 BAR) 42 - 1,5 (8 BAR)	8 - 114	0,75 - 0,5	Single	72	36,5 - 81	46 x 43 x 83
EXTREME 2D 50L 0,75	50	✓	2	200 - 7,0	60 - 2,1 (5 BAR) 42 - 1,5 (8 BAR)	8 - 114	0,75 - 0,5	Single	72	45 - 99	58,5 x 43 x 83
EXTREME 2V 50L 1,50	50	X	2	240 - 8,5	125 - 4,4 (5 BAR) 100 - 3,5 (8 BAR)	8 - 114	1,50 - 1,1	Single	72	39,5 - 87	46 x 43 x 83
EXTREME 2D 50L 1,50	50	✓	2	240 - 8,5	125 - 4,4 (5 BAR) 100 - 3,5 (8 BAR)	8 - 114	1,50 - 1,1	Single	72	48 - 106	58,5 x 43 x 83
EXTREME 2V 50L 2,00	50	X	2	350 - 12,4	156 - 5,5 (5 BAR) 127 - 4,5 (8 BAR)	8 - 114	2,00 - 1,5	Single	73	42,5 - 94	46 x 43 x 83
EXTREME 2D 50L 2,00	50	✓	2	350 - 12,4	156 - 5,5 (5 BAR) 127 - 4,5 (8 BAR)	8 - 114	2,00 - 1,5	Single	73	51 - 112	58,5 x 43 x 83
EXTREME 2V 50L 2,50	50	X	4	480 - 17,0	240 - 8,5 (5 BAR) 190 - 6,7 (8 BAR)	8 - 114	2,50 - 1,84	Single	73	52 - 115	64 x 45 x 89
EXTREME 2D 50L 2,50	50	✓	4	480 - 17,0	240 - 8,5 (5 BAR) 190 - 6,7 (8 BAR)	8 - 114	2,50 - 1,84	Single	73	60 - 132	64 x 45 x 89
EXTREME 2V 50L 3,00	50	X	4	600 - 21,2	312 - 11 (5 BAR) 250 - 8,8 (8 BAR)	10 - 145	3,00 - 2,2	Three	73	54 - 119	64 x 45 x 89
EXTREME 2D 50L 3,00	50	✓	4	600 - 21,2	312 - 11 (5 BAR) 250 - 8,8 (8 BAR)	10 - 145	3,00 - 2,2	Three + N	73	62 - 136	64 x 45 x 89

With automatic thermal protection

Con protezione termica automatica

EXTREME 2D 100 Liters



Packing

Imballo

Weight with box (EXTREME 2D 2,0HP) :

Kg 70 - 154 Lbs

Box dimensions cm : 60 x 45 x 142 (0,39 m³)

Quantity per (110x110) PALLET : 2 pc.

Dental unit 	Pneumatic		
	Electric-Pneumatic		
	Electric		
EXTREME 2,00	2	2	1
EXTREME 2,50	5	3	2
EXTREME 3,00	6	4	3

Compressor Model	Tank	Dryer	Cylinders	Air Intake	Air delivery	Pressure	Power	Phase	Noise	Weight	Dimensions
Modello Compressore	Serb.	Essicat.	Cilindri	Aria Aspirata	Aria resa	Pressione	Motore	Fase	Rumore	Peso	Dimensioni
Type	Liters	Complete	N°	l/min. - C.F.M.	l/min. - C.F.M.	Bar - Psi	HP - kW	Type	dB	Kg - Lbs	cm (LxWxH)
EXTREME 2V 100L 2,00	100	✗	2	350 - 12,4	156 - 5,5 (5 BAR) 127 - 4,5 (8 BAR)	8 - 114	2,00 - 1,5	Single	73	57 - 127	46 x 43 x 140
EXTREME 2D 100L 2,00	100	✓	2	350 - 12,4	156 - 5,5 (5 BAR) 127 - 4,5 (8 BAR)	8 - 114	2,00 - 1,5	Single	73	66 - 145	58,5 x 43 x 140
EXTREME 2V 100L 2,50	100	✗	4	480 - 17,0	240 - 8,5 (5 BAR) 190 - 6,7 (8 BAR)	8 - 114	2,50 - 1,84	Single	73	67 - 147	64 x 45 x 140
EXTREME 2D 100L 2,50	100	✓	4	480 - 17,0	240 - 8,5 (5 BAR) 190 - 6,7 (8 BAR)	8 - 114	2,50 - 1,84	Single	73	75 - 165	64 x 45 x 140
EXTREME 2V 100L 3,00	100	✗	4	600 - 21,2	312 - 11 (5 BAR) 250 - 8,8 (8 BAR)	10 - 145	3,00 - 2,2	Three	73	69 - 152	64 x 45 x 140
EXTREME 2D 100L 3,00	100	✓	4	600 - 21,2	312 - 11 (5 BAR) 250 - 8,8 (8 BAR)	10 - 145	3,00 - 2,2	Three + N	73	77 - 169	64 x 45 x 140

With automatic thermal protection

Con protezione termica automatica

MADE IN ITALY BY NARDI COMPRESSORI

Page 07



Packing Imballo

Weight with box (EXTREME 3D 1,5HP) :
50 Kg - 112 Lbs
Box dimensions cm : 88 x 48 x 72 (0,30 m³)
Quantity per (110x110) PALLET : 8 pc.

Dental unit 	Pneumatic		
	Electric-Pneumatic		
	Electric		
EXTREME 0,75	1	X	X
EXTREME 1,50	2	1	1
EXTREME 2,00	2	2	1

Compressor Model	Tank	Dryer	Cylinders	Air Intake	Air delivery	Pressure	Power	Phase	Noise	Weight	Dimensions
Modello Compressore	Serb.	Essicat.	Cilindri	Aria Aspirata	Aria resa	Pressione	Motore	Fase	Rumore	Peso	Dimensioni
Type	Liters	Complete	N°	l/min. - C.F.M.	l/min. - C.F.M.	Bar - Psi	HP - kW	Tipe	dB	Kg - Lbs	cm (LxWxH)
EXTREME 3V 50L 0,75	50	X	2	200 - 7,0	60 - 2,1 (5 BAR) 42 - 1,5 (8 BAR)	8 - 114	0,75 - 0,5	Single	72	37 - 82	84 x 31 x 68
EXTREME 3D 50L 0,75	50	✓	2	200 - 7,0	60 - 2,1 (5 BAR) 42 - 1,5 (8 BAR)	8 - 114	0,75 - 0,5	Single	72	44,5 - 98	84 x 44 x 68
EXTREME 3V 50L 1,50	50	X	2	240 - 8,5	125 - 4,4 (5 BAR) 100 - 3,5 (8 BAR)	8 - 114	1,50 - 1,1	Single	72	40 - 88	84 x 31 x 68
EXTREME 3D 50L 1,50	50	✓	2	240 - 8,5	125 - 4,4 (5 BAR) 100 - 3,5 (8 BAR)	8 - 114	1,50 - 1,1	Single	72	47,5 - 105	84 x 44 x 68
EXTREME 3V 50L 2,00	50	X	2	350 - 12,4	156 - 5,5 (5 BAR) 127 - 4,5 (8 BAR)	8 - 114	2,00 - 1,5	Single	73	43 - 95	84 x 31 x 68
EXTREME 3D 50L 2,00	50	✓	2	350 - 12,4	156 - 5,5 (5 BAR) 127 - 4,5 (8 BAR)	8 - 114	2,00 - 1,5	Single	73	50,5 - 112	84 x 44 x 68

With automatic thermal protection

Con protezione termica automatica

EXTREME 4D 90 Liters

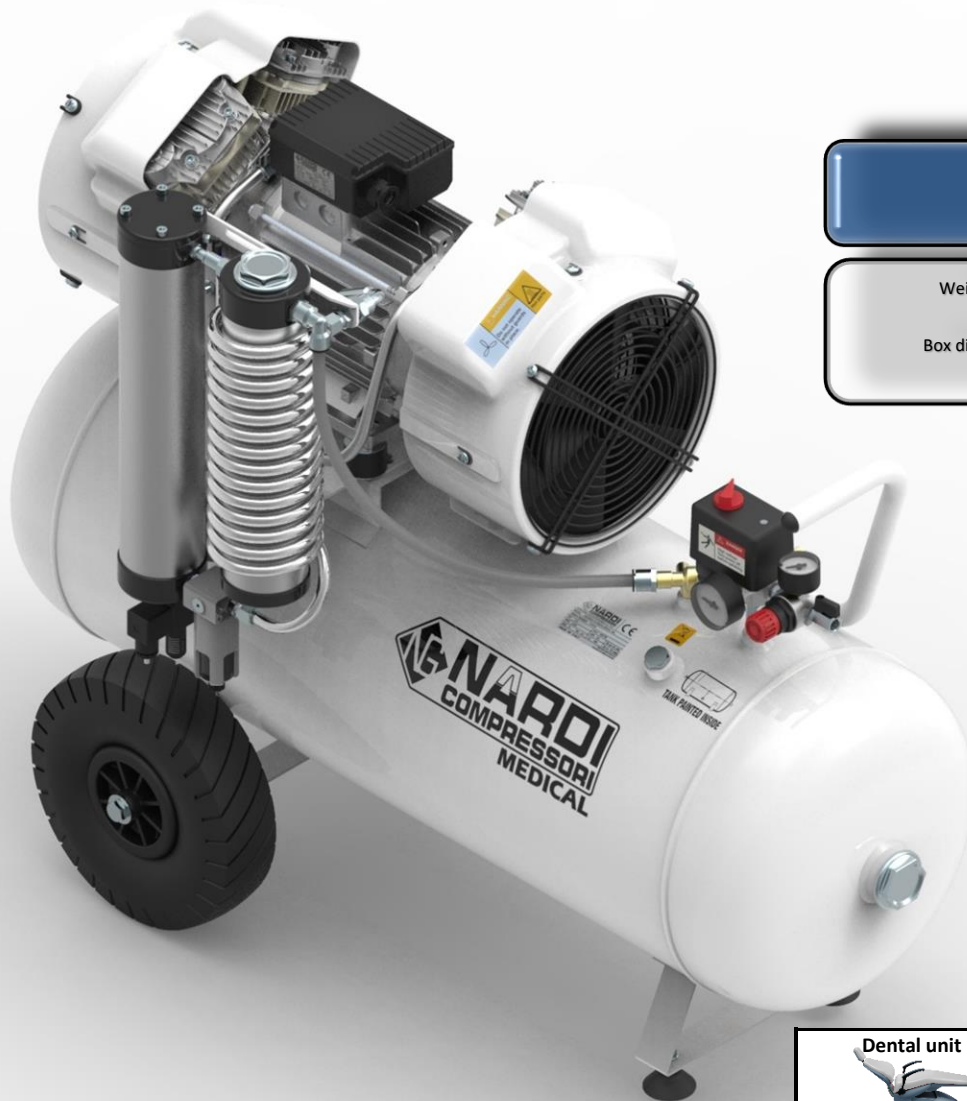

Packing Imballo

Weight with box (EXTREME 4D 2,5HP) :
96 Kg - 211 Lbs
Box dimensions cm : 113 x 60 x 84 (0,54m³)
Quantity per EUR PALLET : 2 pc.

Dental unit 	Pneumatic		
	Electric-Pneumatic		
	Electric		
EXTREME 2,00	2	2	1
EXTREME 2,50	5	3	2
EXTREME 3,00	6	4	3

Compressor Model	Tank	Dryer	Cylinders	Air Intake	Air delivery	Pressure	Power	Phase	Noise	Weight	Dimensions
Modello Compressore	Serb.	Essicat.	Cilindri	Aria Aspirata	Aria resa	Pressione	Motore	Fase	Rumore	Peso	Dimensioni
Type	Liters	Complete	N°	l/min. - C.F.M.	l/min. - C.F.M.	Bar - Psi	HP - kW	Tippe	dB	Kg - Lbs	cm (LxWxH)
EXTREME 4V 90L 2,00	90	X	2	350 - 12,4	156 - 5,5 (5 BAR) 127 - 4,5 (8 BAR)	8 - 114	2,00 - 1,5	Single	73	67 - 147	110 x 54 x 81
EXTREME 4D 90L 2,00	90	✓	2	350 - 12,4	156 - 5,5 (5 BAR) 127 - 4,5 (8 BAR)	8 - 114	2,00 - 1,5	Single	73	76 - 167	110 x 59 x 81
EXTREME 4V 90L 2,50	90	X	4	480 - 17,0	240 - 8,5 (5 BAR) 190 - 6,7 (8 BAR)	8 - 114	2,50 - 1,85	Single	73	77 - 170	110 x 54 x 81
EXTREME 4D 90L 2,50	90	✓	4	480 - 17,0	240 - 8,5 (5 BAR) 190 - 6,7 (8 BAR)	8 - 114	2,50 - 1,85	Single	73	86 - 189	110 x 59 x 81
EXTREME 4V 90L 3,00	90	X	4	600 - 21,2	312 - 11 (5 BAR) 250 - 8,8 (8 BAR)	10 - 145	3,00 - 2,2	Three	73	79 - 175	110 x 54 x 81
EXTREME 4D 90L 3,00	90	✓	4	600 - 21,2	312 - 11 (5 BAR) 250 - 8,8 (8 BAR)	10 - 145	3,00 - 2,2	Three + N	73	88 - 194	110 x 59 x 81

With automatic thermal protection

Con protezione termica automatica

MADE IN ITALY BY NARDI COMPRESSORI

Page 09



Packing Imballo

Weight with box (EXTREME 2D SIL 25L 1,5HP) :
45,5 Kg - 100 Lbs
Box dimensions cm : 70 x 43 x 78 (0,23m³)
Quantity per EUR PALLET : 4 pc.

 Dental unit	Pneumatic		
	Electric-Pneumatic		
	Electric		
EXTREME 0,75	1	X	X
EXTREME 1,50	2	1	1
EXTREME 2,00	2	2	1

Compressor Model	Tank	Dryer	Cylinders	Air Intake	Air delivery	Pressure	Power	Phase	Noise	Weight	Dimensions
Modello Compressore	Serb.	Essicat.	Cilindri	Aria Aspirata	Aria resa	Pressione	Motore	Fase	Rumore	Peso	Dimensioni
Type	Liters	Complete	N°	l/min. - C.F.M.	l/min. - C.F.M.	Bar - Psi	HP - kW	Type	dB	Kg - Lbs	cm (LxWxH)
EXTREME 2V SIL 25L 0,75	25	X	2	200 - 7,0	60 - 2,1 (5 BAR) 42 - 1,5 (8 BAR)	8 - 114	0,75 - 0,5	Single	66	36 - 79,5	58 x 43 x 78
EXTREME 2D SIL 25L 0,75	25	✓	2	200 - 7,0	60 - 2,1 (5 BAR) 42 - 1,5 (8 BAR)	8 - 114	0,75 - 0,5	Single	66	43 - 95	70 x 43 x 78
EXTREME 2V SIL 25L 1,50	25	X	2	240 - 8,5	125 - 4,4 (5 BAR) 100 - 3,5 (8 BAR)	8 - 114	1,50 - 1,1	Single	66	38,5 - 85	58 x 43 x 78
EXTREME 2D SIL 25L 1,50	25	✓	2	240 - 8,5	125 - 4,4 (5 BAR) 100 - 3,5 (8 BAR)	8 - 114	1,50 - 1,1	Single	66	45,5-100	70 x 43 x 78
EXTREME 2V SIL 25L 2,00	25	X	2	350 - 12,4	156 - 5,5 (5 BAR) 127 - 4,5 (8 BAR)	8 - 114	2,00 - 1,5	Single	67	41 - 90	58 x 43 x 78
EXTREME 2D SIL 25L 2,00	25	✓	2	350 - 12,4	156 - 5,5 (5 BAR) 127 - 4,5 (8 BAR)	8 - 114	2,00 - 1,5	Single	67	48 - 106	70 x 43 x 78

With automatic thermal protection

Con protezione termica automatica

EXTREME 2D SIL 50 Liters



Packing

Imballo

Weight with box (EXTREME 2D SIL 50L 1,5HP) :

48 Kg - 106 Lbs

Box dimensions cm : 70 x 43 x 98 (0,30m³)

Quantity per EUR PALLET : 4 pc.

Dental unit 	Pneumatic		
	Electric-Pneumatic		
	Electric		
EXTREME 0,75	1	X	X
EXTREME 1,50	2	1	1
EXTREME 2,00	2	2	1

Compressor Model	Tank	Dryer	Cylinders	Air Intake	Air delivery	Pressure	Power	Phase	Noise	Weight	Dimensions
Modello Compressore	Serb.	Essicat.	Cilindri	Aria Aspirata	Aria resa	Pressione	Motore	Fase	Rumore	Peso	Dimensioni
Type	Liters	Complete	N°	l/min. - C.F.M.	l/min. - C.F.M.	Bar - Psi	HP - kW	Type	dB	Kg - Lbs	cm (LxWxH)
EXTREME 2V SIL 50L 0,75	50	X	2	200 - 7,0	60 - 2,1 (5 BAR) 42 - 1,5 (8 BAR)	8 - 114	0,75 - 0,5	Single	66	42 - 92,5	58 x 43 x 98
EXTREME 2D SIL 50L 0,75	50	✓	2	200 - 7,0	60 - 2,1 (5 BAR) 42 - 1,5 (8 BAR)	8 - 114	0,75 - 0,5	Single	66	50 - 110	70 x 43 x 98
EXTREME 2V SIL 50L 1,50	50	X	2	240 - 8,5	125 - 4,4 (5 BAR) 100 - 3,5 (8 BAR)	8 - 114	1,50 - 1,1	Single	66	45 - 99	58 x 43 x 98
EXTREME 2D SIL 50L 1,50	50	✓	2	240 - 8,5	125 - 4,4 (5 BAR) 100 - 3,5 (8 BAR)	8 - 114	1,50 - 1,1	Single	66	53 - 117	70 x 43 x 98
EXTREME 2V SIL 50L 2,00	50	X	2	350 - 12,4	156 - 5,5 (5 BAR) 127 - 4,5 (8 BAR)	8 - 114	2,00 - 1,5	Single	67	47 - 103	58 x 43 x 98
EXTREME 2D SIL 50L 2,00	50	✓	2	350 - 12,4	156 - 5,5 (5 BAR) 127 - 4,5 (8 BAR)	8 - 114	2,00 - 1,5	Single	67	55 - 122	70 x 43 x 98

With automatic thermal protection

Con protezione termica automatica

MADE IN ITALY BY NARDI COMPRESSORI

Page 11



Packing

Imballo

Weight with box (EXTREME SD 1,5HP) :

78 Kg - 172 Lbs

Box dimensions cm : 73 x 47 x 79 (0,24m³)

Quantity per EUR PALLET : 4 pc.

 Dental unit	Pneumatic		
	Electric-Pneumatic		
	Electric		
EXTREME 0,75	1	X	X
EXTREME 1,50	2	1	1
EXTREME 2,00	2	2	1

Compressor Model	Tank	Dryer	Cylinders	Air Intake	Air delivery	Pressure	Power	Phase	Noise	Weight	Dimensions
Modello Compressore	Serb.	Essicat.	Cilindri	Aria Aspirata	Aria resa	Pressione	Motore	Fase	Rumore	Peso	Dimensioni
Type	Liters	Complete	N°	l/min. - C.F.M.	l/min. - C.F.M.	Bar - Psi	HP - kW	Type	dB	Kg - Lbs	cm (LxWxH)
EXTREME SV 30L 0,75	30	X	2	200 - 7,0	60 - 2,1 (5 BAR) 42 - 1,5 (8 BAR)	8 - 114	0,75 - 0,5	Single	63	65,5 - 145	65 x 44 x 76
EXTREME SD 30L 0,75	30	✓	2	200 - 7,0	60 - 2,1 (5 BAR) 42 - 1,5 (8 BAR)	8 - 114	0,75 - 0,5	Single	63	72,5 - 159	71 x 44 x 76
EXTREME SV 30L 1,50	30	X	2	240 - 8,5	125 - 4,4 (5 BAR) 100 - 3,5 (8 BAR)	8 - 114	1,50 - 1,1	Single	63	68 - 150	65 x 44 x 76
EXTREME SD 30L 1,50	30	✓	2	240 - 8,5	125 - 4,4 (5 BAR) 100 - 3,5 (8 BAR)	8 - 114	1,50 - 1,1	Single	63	75 - 165	71 x 44 x 76
EXTREME SV 30L 2,00	30	X	2	350 - 12,4	156 - 5,5 (5 BAR) 127 - 4,5 (8 BAR)	8 - 114	2,00 - 1,5	Single	64	71,5 - 158	65 x 44 x 76
EXTREME SD 30L 2,00	30	✓	2	350 - 12,4	156 - 5,5 (5 BAR) 127 - 4,5 (8 BAR)	8 - 114	2,00 - 1,5	Single	64	78,5 - 173	71 x 44 x 76

With automatic thermal protection

Con protezione termica automatica

EXTREME SD 50 Liters



Packing Imballo

Weight with box (EXTREME SD 1,5HP) :
90 Kg - 199 Lbs
Box dimensions cm : 85 x 52 x 84 (0,34m³)
Quantity per EUR PALLET : 2 pc.

Dental unit 	Pneumatic		
	Electric-Pneumatic		
	Electric		
EXTREME 0,75	1	X	X
EXTREME 1,50	2	1	1
EXTREME 2,00	2	2	1

Compressor Model	Tank	Dryer	Cylinders	Air Intake	Air delivery	Pressure	Power	Phase	Noise	Weight	Dimensions
Modello Compressore	Serb.	Essicat.	Cilindri	Aria Aspirata	Aria resa	Pressione	Motore	Fase	Rumore	Peso	Dimensioni
Type	Liters	Complete	N°	l/min. - C.F.M.	l/min. - C.F.M.	Bar - Psi	HP - kW	Type	dB	Kg - Lbs	cm (LxWxH)
EXTREME SV 50L 0,75	50	X	2	200 - 7,0	60 - 2,1 (5 BAR) 42 - 1,5 (8 BAR)	8 - 114	0,75 - 0,5	Single	61	80,5 - 177	72 x 50 x 82
EXTREME SD 50L 0,75	50	✓	2	200 - 7,0	60 - 2,1 (5 BAR) 42 - 1,5 (8 BAR)	8 - 114	0,75 - 0,5	Single	61	88 - 194	85 x 50 x 82
EXTREME SV 50L 1,50	50	X	2	240 - 8,5	125 - 4,4 (5 BAR) 100 - 3,5 (8 BAR)	8 - 114	1,50 - 1,1	Single	61	83 - 183	72 x 50 x 82
EXTREME SD 50L 1,50	50	✓	2	240 - 8,5	125 - 4,4 (5 BAR) 100 - 3,5 (8 BAR)	8 - 114	1,50 - 1,1	Single	61	90 - 199	85 x 50 x 82
EXTREME SV 50L 2,00	50	X	2	350 - 12,4	156 - 5,5 (5 BAR) 127 - 4,5 (8 BAR)	8 - 114	2,00 - 1,5	Single	62	86,5 - 195	72 x 50 x 82
EXTREME SD 50L 2,00	50	✓	2	350 - 12,4	156 - 5,5 (5 BAR) 127 - 4,5 (8 BAR)	8 - 114	2,00 - 1,5	Single	62	95,5 - 210	85 x 50 x 82

With automatic thermal protection
Con protezione termica automatica
MADE IN ITALY BY NARDI COMPRESSORI

THE NEW NARDI LP CONTROL DEVICE - TOTAL CONTROL, COMPLETELY INDEPENDENT, ENERGY SAVING EFFICIENCY AND SAFETY RELIABILITY OF NARDI COMPRESSORI.

(ENG) This is an automatic electronic controller, flexible and reliable with a large display and touch commands in an easy-to-use modern and compact design. The LP CONTROL DEVICE controls up to three pump units autonomously depending on the air quantity requirement of the user which rules the starting up of a single or more pump units. Therefore, the amount of air needed would give the system the input to run the pump units one by one to cater for the air quantity needed. When a limited amount of air is needed, the LP CONTROL DEVICE starts a single pump unit, on rotation, this way all pump units will have an equal working time. If more air is needed and a single pump unit is not enough, then the LPCD will start the second electric motor and in case more power is needed to reach the pressure needed, it will also run the third electric motor. This kind of working sequence of the pump units is an important energy saver since it avoids frequent and high peaks of electrical consumption. In manual mode, during maintenance operations on one or more pump units, the user selects which pump unit to run and which one/s to keep turned off.



The automatic control device memorizes the total working hours of the compressor and the working hours of every single pump unit and dryer installed. The motor switches have a thermal control which, in case of an electric overload, stops the motor and informs the automatic system of an ongoing malfunction. This will immediately start another motor this way there is no halt in the work of the user. The LPCD launches a message when the compressor is due for regular maintenance since the working hours of all pump units on the compressor are equal, and also in case any alarm activates. It is possible to collocate up to 10 LP CONTROL DEVICES, therefore a maximum of 30 pump units by means of an RS485 connection.

This controlled system consents a better stability of the process, optimization of the compressor and the pumping units, maximization of the working hours, reduction of energy costs and minimum maintenance operations. Upon request, it is possible to add an extra module to have the LPCD send notifications to a determined email address giving real time information about the conditions of the compressor (IoT system).

IL NUOVO NARDI LP CONTROL DEVICE - TOTALE CONTROLLO, COMPLETA AUTONOMIA, EFFICIENTE RISPARMIO ENERGETICO E L’AFFIDABILE SICUREZZA NARDI COMPRESSORI.

(ITA) Sistema di gestione elettronico automatico, flessibile ed affidabile, grande display e comoda pulsantiera, di facile utilizzo e dal design moderno e compatto. Il sistema di gestione LP CONTROL DEVICE comanda fino a tre gruppi pompanti in maniera autonoma, in base alla richiesta d’aria da parte dell’utente. L’avviamento di uno o più gruppi pompanti, è dato dal consumo d’aria dell’utente. In base alla quantità di aria richiesta, la gestione automatica LP CONTROL DEVICE accenderà uno alla volta i motori elettrici in base al fabbisogno d’aria. Se il consumo d’aria è ridotto, farà partire un solo motore, a rotazione con gli altri due, in base al monte ore di lavoro accumulato. Se invece il fabbisogno d’aria è più elevato ed un solo pompante non è sufficiente, allora la gestione automatica farà partire anche il secondo motore elettrico, e di conseguenza, a valori di pressione stabili, accenderà anche il terzo motore elettrico. Questo tipo di gestione dei pompanti, fa risparmiare corrente elettrica ed evita spunti di consumo elettrico frequenti e troppo elevati. In modalità manuale invece, è l’utente a decidere quale gruppo pompante utilizzare e quale invece fermare, in caso di manutenzione ad uno o più dei pompanti.

Il sistema di gestione automatico LP CONTROL DEVICE controlla le ore di lavoro totali del compressore e le ore di lavoro di ogni singolo gruppo pompante e, di conseguenza, anche degli essiccatori. Il comando motori è provvisto di controllo termico, che in caso di eccessivo assorbimento di corrente elettrica, ferma il motore, comunica alla gestione automatica il malfunzionamento, e fa partire subito un altro motore elettrico, così da non fermare l’utente nel suo lavoro. Il sistema avvisa quando il compressore deve fare la manutenzione programmata ed ogni eventuale allarme riscontrato. La manutenzione viene effettuata su tutti i gruppi pompanti durante la stessa manutenzione, in quanto le ore di lavoro sono uguali per tutti i pompanti presenti sul compressore. È possibile affiancare e collegare tra loro fino a 10 LP CONTROL DEVICE, quindi fino a 30 gruppi pompanti, tramite collegamento RS485.

Questo sistema di gestione controllata, consente maggiore stabilità del processo, l’ottimizzazione del compressore e dei gruppi pompanti, l’ottimizzazione dei tempi di lavoro, la riduzione del costo energetico e manutenzione minima. A richiesta, è possibile aggiungere il modulo per la comunicazione dei guasti tramite mail, ad un determinato indirizzo di posta elettronica, per essere sempre informati in tempo reale sulle condizioni del compressore (sistema IoT).

EXTREME MP 270 Liters



Packing

Imballo

Weight with box (EXTREME MPD 270 9,0HP) :
280 Kg - 617 Lbs
Box dimensions cm : 170 x 95 x 110 (1,78 m³)
Quantity per PALLET : 1 pc.

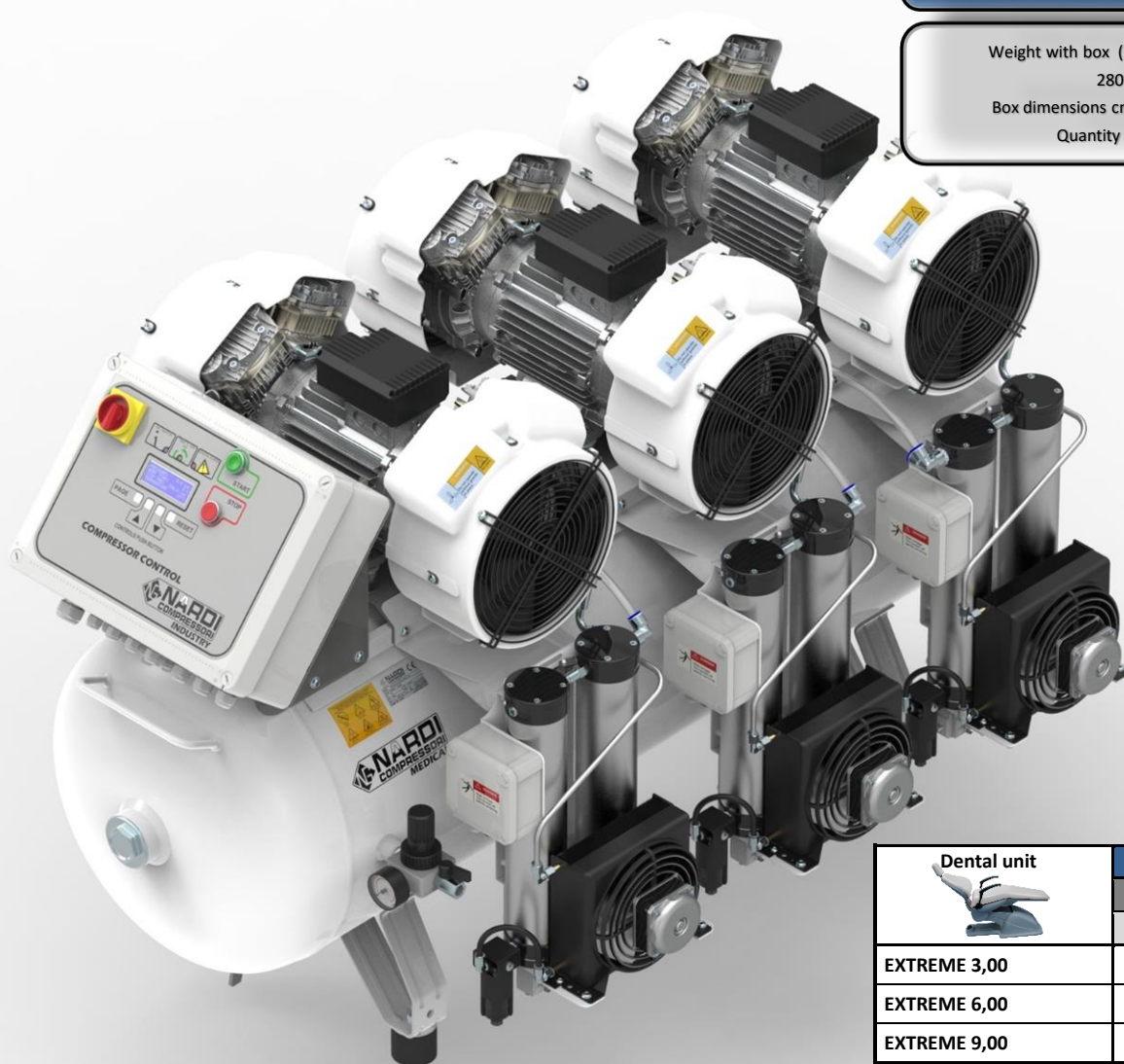

 Dental unit	Pneumatic		
	Electric-Pneumatic		
	Electric		
EXTREME 3,00	6	4	3
EXTREME 6,00	12	8	6
EXTREME 9,00	18	12	9

Compressor Model	Tank	Dryer	Cylinders	Air Intake	Air delivery	Pressure	Power	Phase	Noise	Weight	Dimensions
Modello Compressore	Serb.	Essicat.	Cilindri	Aria Aspirata	Aria resa	Pressione	Motore	Fase	Rumore	Peso	Dimensioni
Type	Liters	Complete	N°	l/min. - C.F.M.	l/min. - C.F.M.	Bar - Psi	HP - kW	Tippe	dB	Kg - Lbs	cm (LxWxH)
EXTREME MPV 270L 3,0	270	X	4	600 - 21,2	312 - 11 (5 BAR) 250 - 8,8 (8 BAR)	10 - 145	3,00 - 2,2	Three	73	116 - 255	160 x 64 x 87
EXTREME MPD 270L 3,0	270	✓	4	600 - 21,2	312 - 11 (5 BAR) 250 - 8,8 (8 BAR)	10 - 145	3,00 - 2,2	Three + N	73	130 - 287	160 x 93 x 87
EXTREME MPV 270L 6,0	270	X	8	1200 - 42,4	624 - 22 (5 BAR) 500 - 18 (8 BAR)	10 - 145	6,00 - 4,4	Three	74	165 - 364	160 x 64 x 87
EXTREME MPD 270L 6,0	270	✓	8	1200 - 42,4	624 - 22 (5 BAR) 500 - 18 (8 BAR)	10 - 145	6,00 - 4,4	Three	74	193 - 425	160 x 93 x 87
EXTREME MPV 270L 9,0	270	X	12	1800 - 63,6	936 - 33 (5 BAR) 750 - 27 (8 BAR)	10 - 145	9,00 - 6,6	Three	75	198 - 436	160 x 64 x 87
EXTREME MPD 270L 9,0	270	✓	12	1800 - 63,6	936 - 33 (5 BAR) 750 - 27 (8 BAR)	10 - 145	9,00 - 6,6	Three	75	240 - 530	160 x 93 x 87

With automatic thermal protection

Con protezione termica automatica

MADE IN ITALY BY NARDI COMPRESSORI

Page 15

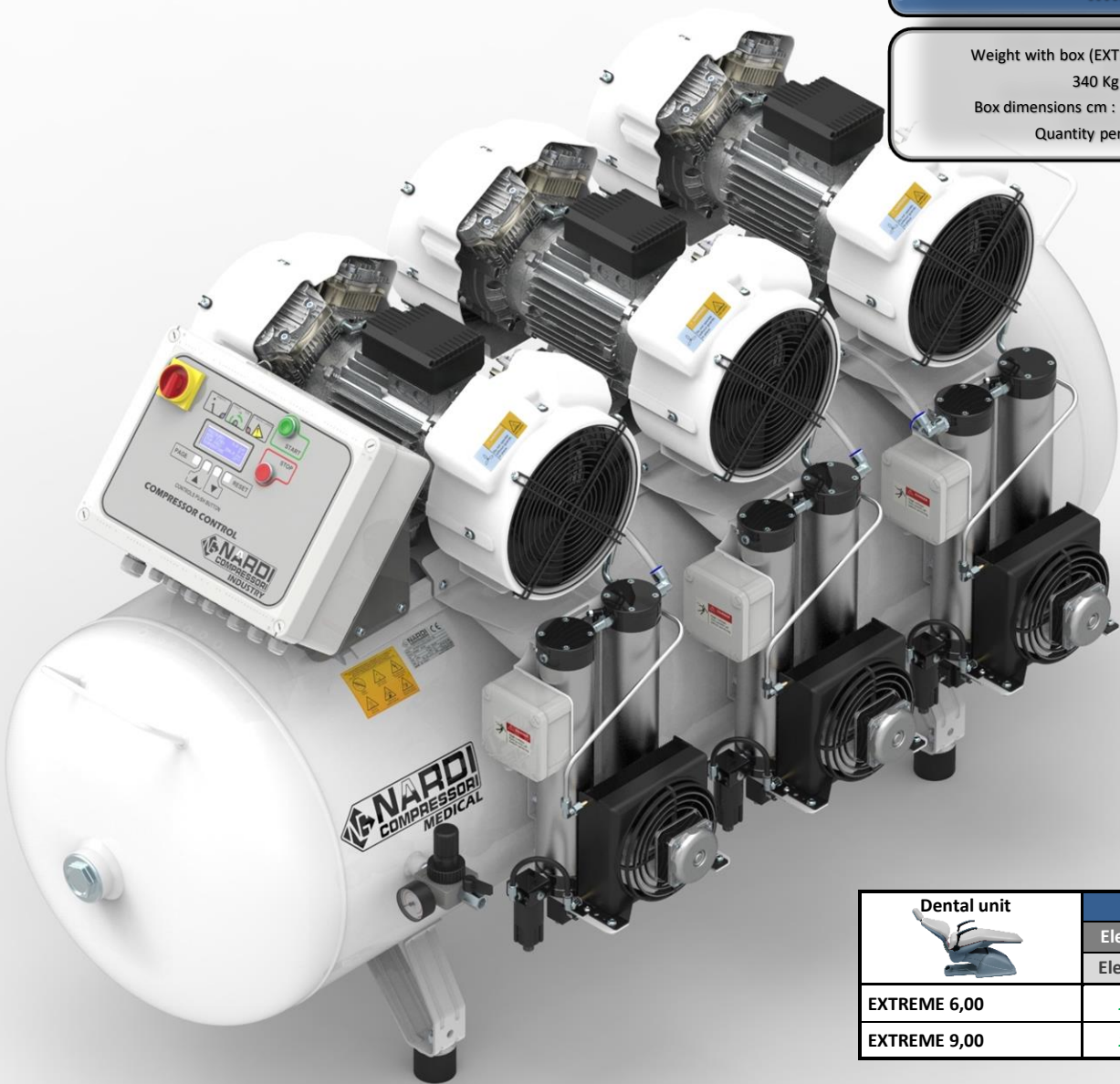

Packing Imballo

Weight with box (EXTREME MPD 500 9,0HP) :
340 Kg - 750 Lbs
Box dimensions cm : 200 x 120 x 120 (2,9 m³)
Quantity per PALLET : 1 pc.

Dental unit 	Pneumatic		
	Electric-Pneumatic		
	Electric		
EXTREME 6,00	12	8	6
EXTREME 9,00	18	12	9

Compressor Model	Tank	Dryer	Cylinders	Air Intake	Air delivery	Pressure	Power	Phase	Noise	Weight	Dimensions
Modello Compressore	Serb.	Essicat.	Cilindri	Aria Aspirata	Aria resa	Pressione	Motore	Fase	Rumore	Peso	Dimensioni
Type	Liters	Complete	N°	l/min. - C.F.M.	l/min. - C.F.M.	Bar - Psi	HP - kW	Tipe	dB	Kg - Lbs	cm (LxWxH)
EXTREME MPV 500L 6,00	500	X	8	1200 - 42,4	624 - 22 (5 BAR) 500 - 18 (8 BAR)	10 - 145	6,00 - 4,4	Three	74	220 - 485	195 x 64 x 110
EXTREME MPD 500L 6,00	500	✓	8	1200 - 42,4	624 - 22 (5 BAR) 500 - 18 (8 BAR)	10 - 145	6,00 - 4,4	Three	74	248 - 547	195 x 93 x 110
EXTREME MPV 500L 9,00	500	X	12	1800 - 63,6	936 - 33 (5 BAR) 750 - 27 (8 BAR)	10 - 145	9,00 - 6,6	Three	75	253 - 558	195 x 64 x 110
EXTREME MPD 500L 9,00	500	✓	12	1800 - 63,6	936 - 33 (5 BAR) 750 - 27 (8 BAR)	10 - 145	9,00 - 6,6	Three	75	295 - 650	195 x 93 x 110

With automatic thermal protection
Con protezione termica automatica
MADE IN ITALY BY NARDI COMPRESSORI

DRYER



Model	Air filtration (5 BAR)	Duty cycle	Power	Purge	Max Pressure	Weight	Dimensions
Modello	Aria filtrata (5 BAR)	Ciclo di lavoro	Consumo	Perdita di carico	Pressione mass.	Peso	Dimensioni
Type	l/min. - C.F.M. - m ³ /h	%	Watt	%	Bar - Psi	Kg - Lbs	cm (LxWxH)
DRYER 400	400 - 14 - 24	80 % (20 min)	18	1 %	10 - 145	7 - 15,5	51 x 26 x 13
DRYER D600	600 - 21,2 - 36	100 %	46	6 %	10 - 145	12 - 26,5	50 x 33 x 26
DRYER M400	400 - 14 - 24	100 %	10	14 %	10 - 145	7 - 15,5	57 x 27 x 26

FILTER DEPURATOR

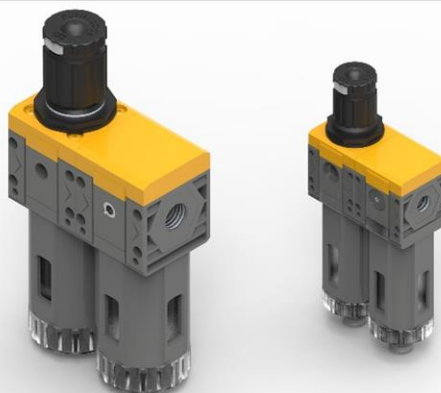

Model	Air filtration (8 BAR)	Duty cycle	Connection	Depuration	Max Pressure	Weight	Dimensions
Modello	Aria filtrata (8BAR)	Ciclo di lavoro	Attacco	Purificazione	Pressione mass.	Peso	Dimensioni
Type	l/min. - C.F.M. - m ³ /h	%	in / out	μm	Bar - Psi	Kg - Lbs	cm (LxWxH)
DEPURATOR 1/4"	460 - 14 - 24	100 %	G1/4" - G1/4"	5 + 0,01	10 - 145	2 - 4,5	8,5 x 4,5 x 19
DEPURATOR 1/2"	990 - 14 - 24	100 %	G1/2" - G1/2"	5 + 0,01	10 - 145	5 - 11	12 x 6 x 23,5

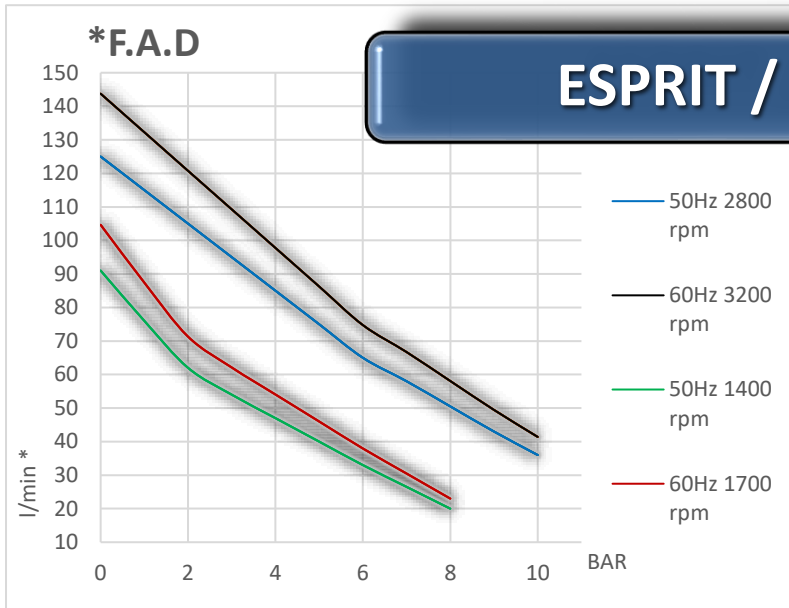

Compressor Model	Cylinders	Air Intake	Pressure	Power	Phase	Revolution	Noise	Weight	Dimensions
Modello Compressore	Cilindri	Aria Aspirata	Pressione	Motore	Fase	Giri	Rumore	Peso	Dimensioni
Type	N°	l/min. - C.F.M. - m ³ /h	Bar - Psi	HP - kW	Tipi	Rpm	dB	Kg - Lbs	cm (LxWxH)
ESPRIT UNIT 60/4	2	105 - 3,7 - 6,3 (50 Hz) 125 - 4,4 - 7,5 (60 Hz)	8 - 114	0,75 - 0,5	Single	1400 1700	48	8 - 17	29 x 22 x 14
ESPRIT UNIT 60/2	2	210 - 7,4 - 12,6 (50 Hz) 250 - 8,8 - 15 (60 Hz)	8 - 114	0,75 - 0,5	Single	2800 3300	55	8 - 17	29 x 22 x 14

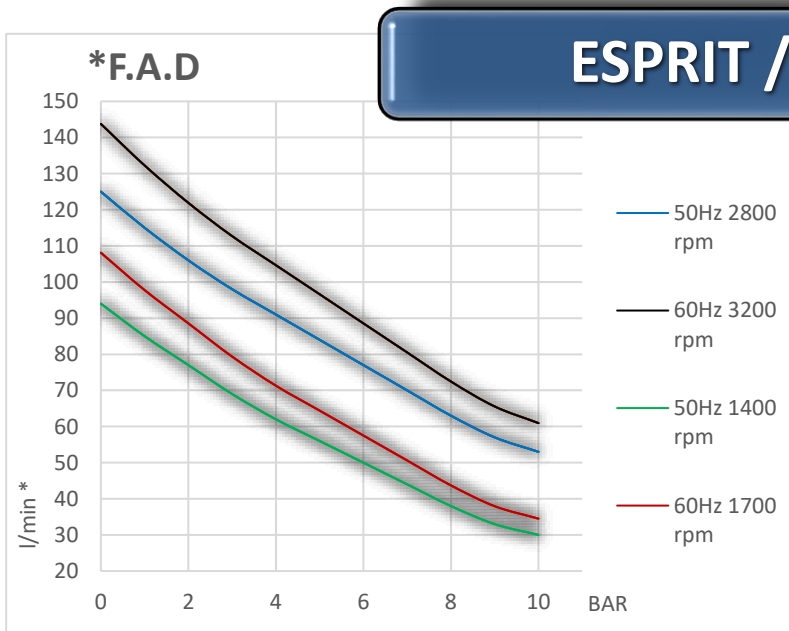

Compressor Model	Cylinders	Air Intake	Max Pressure	Power	Phase	Revolution	Noise	Weight	Dimensions
Modello Compressore	Cilindri	Aria Aspirata	Pressione mass.	Motore	Fase	Giri	Rumore	Peso	Dimensioni
Type	N°	l/min. - C.F.M. - m ³ /h	Bar - Psi	HP - kW	Tipi	Rpm	dB	Kg - Lbs	cm (LxWxH)
ESPRIT UNIT 65/4	2	125 - 4,4 - 7,5 (50 Hz) 150 - 5,3 - 9 (60 Hz)	8 - 114	0,90 - 0,65	Single	1400 1700	49	8,5 - 19	29 x 22 x 14
ESPRIT UNIT 65/2	2	250 - 8,8 - 15 (50 Hz) 300 - 10,5 - 18 (60 Hz)	8 - 114	0,90 - 0,65	Single	2800 3300	56	8,5 - 19	29 x 22 x 14

With automatic thermal protection - * F.A.D. values have a tolerance $\pm 5\%$

Con protezione termica automatica - * I valori indicati hanno una tolleranza $\pm 5\%$

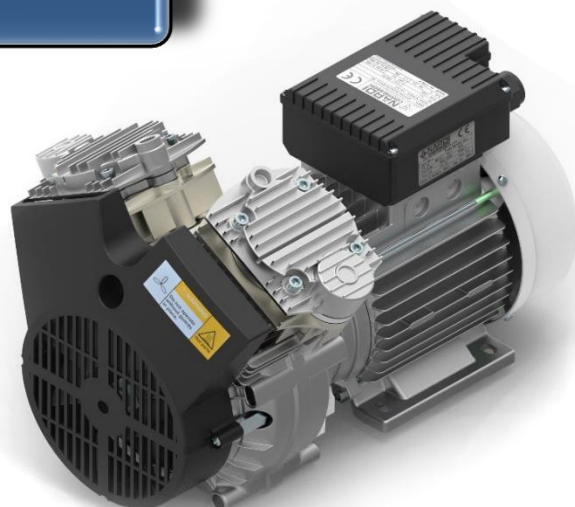
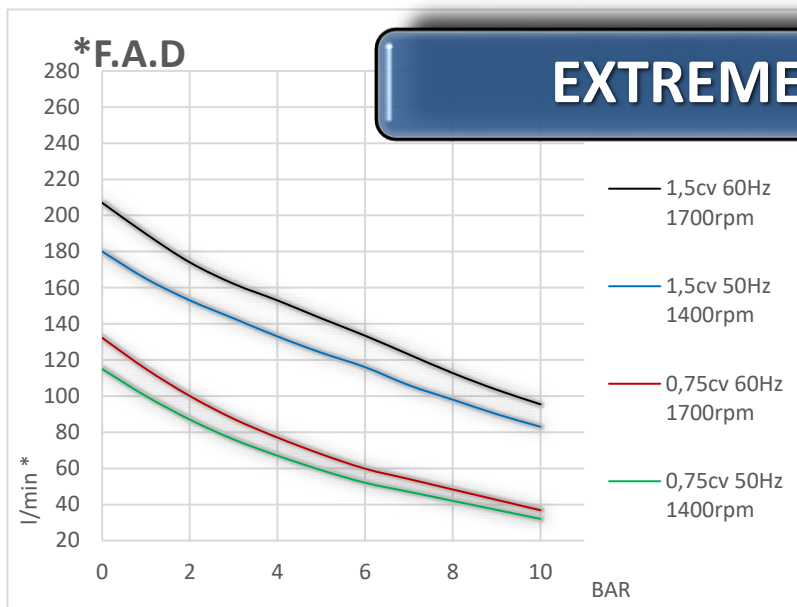

Compressor Model	Cylinders	Air Intake	Max Pressure	Power	Revolution	Noise	Weight	Dimensions
Modello Compressore	Cilindri	Aria Aspirata	Pressione mass.	Motore	Giri	Rumore	Peso	Dimensioni
Type	N°	l/min. - C.F.M. - m³/h	Bar - Psi	HP - kW	Rpm	dB	Kg - Lbs	cm (LxWxH)
EXTREME UNIT 0,75 CV	2	200 - 7,0 - 12 (50 Hz) 240 - 8,5 - 14,4 (60 Hz)	10 - 145	0,75 - 0,55	1400 1700	72	14 - 31	39 x 28 x 26
EXTREME UNIT 1,50 CV	2	240 - 8,5 - 14,4 (50 Hz) 290 - 10,1 - 17,2 (60 Hz)	10 - 145	1,50 - 1,1	1400 1700	72	16,5 - 36	39 x 28 x 26

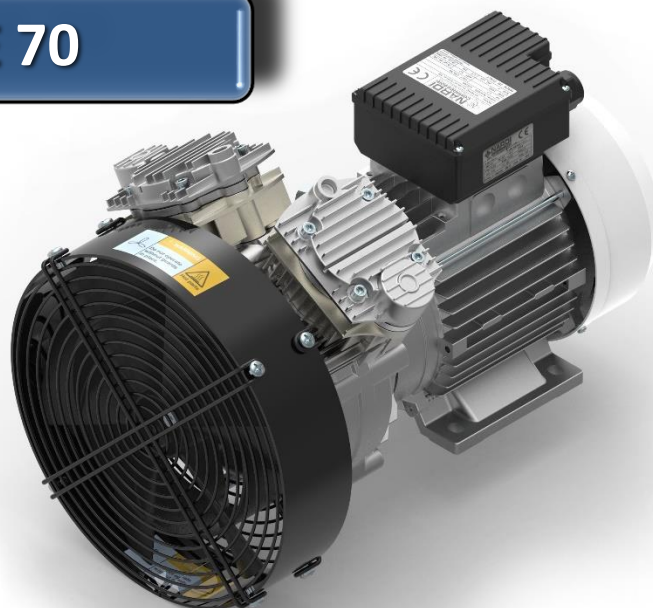
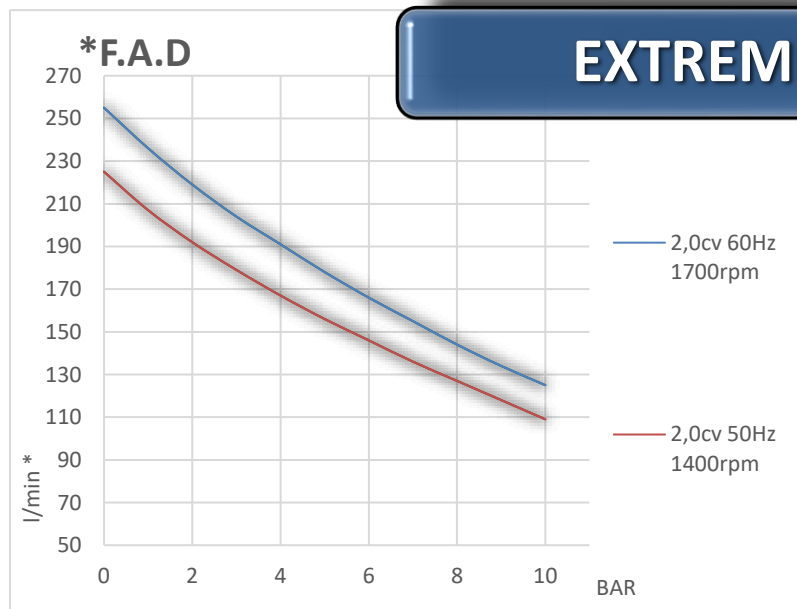

Compressor Model	Cylinders	Air Intake	Max Pressure	Power	Revolution	Noise	Weight	Dimensions
Modello Compressore	Cilindri	Aria Aspirata	Pressione mass.	Motore	Giri	Rumore	Peso	Dimensioni
Type	N°	l/min. - C.F.M. - m³/h	Bar - Psi	HP - kW	Rpm	dB	Kg - Lbs	cm (LxWxH)
EXTREME UNIT 2 CV 1400	2	350 - 12,4 - 21 (50 Hz) 420 - 14,8 - 25 (60 Hz)	10 - 145	2,00 - 1,5	1400 1700	73	20 - 44	43 x 28 x 29

With automatic thermal protection - * F.A.D. values have a tolerance $\pm 5\%$

Con protezione termica automatica - * I valori indicati hanno una tolleranza $\pm 5\%$

MADE IN ITALY BY NARDI COMPRESSORI

Page 19

PUMP UNIT

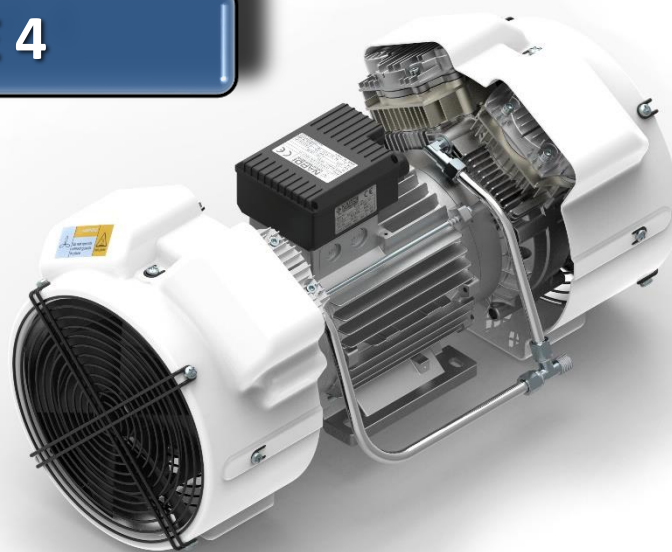
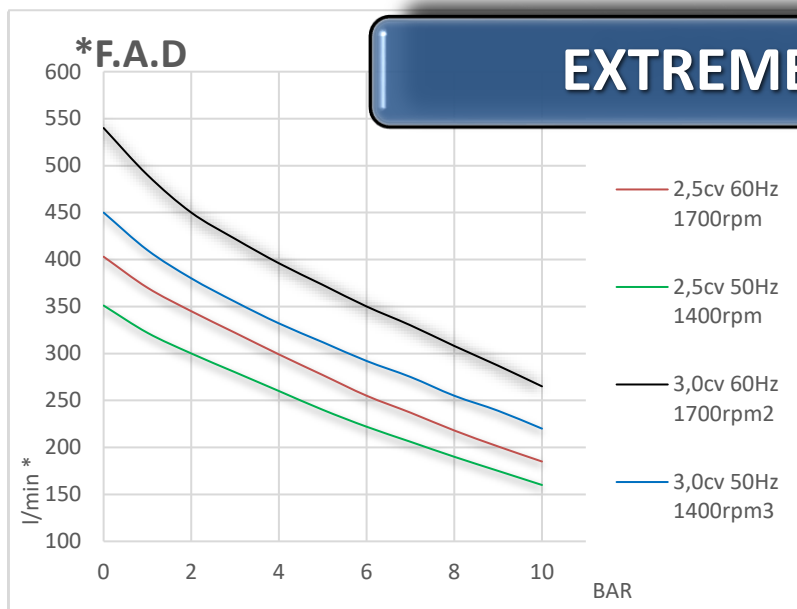

Compressor Model	Cylinders	Air Intake	Max Pressure	Power	Revolution	Noise	Weight	Dimensions
Modello Compressore	Cilindri	Aria Aspirata	Pressione mass.	Motore	Giri	Rumore	Peso	Dimensioni
Type	N°	l/min. - C.F.M. - m³/h	Bar - Psi	HP - kW	Rpm	dB	Kg - Lbs	cm (LxWxH)
EXTREME 4 UNIT 2,50 CV	4	480 - 17 - 29 (50 Hz) 580 - 20 - 35 (60 Hz)	10 - 145	2,50 - 1,84	1400 1700	73	30 - 66	61 x 28 x 31
EXTREME 4 UNIT 3,00 CV	4	600 - 21,2 - 36 (50 Hz) 720 - 25,5 - 43 (60 Hz)	10 - 145	3,00 - 2,2	1400 1700	73	33 - 73	64 x 28 x 31

General terms



General terms of sale (ENGLISH)

Standard Delivery Fornitura standard

Standard Volt/Hertz/Phase : 230/50/1
Other : 100⇒240 Volt/50-60 Hz/1 Phase

STANDARD COLOR : WHITE
Other colors min. delivery : 50 pcs

Standard plug :
SCHUKO

Standard fitting :
1/4" G BALL VALVE

- This catalogue cancels and substitutes the previous versions.
- Once order is confirmed all terms of sale are implicitly accepted.
- The goods are always delivered ex works and at the buyer's risk.
- Any possible complaints about the packing or the delivery are accepted only if notified within 8 days from the date of receipt.
- Our production is warranted for 24 months from the delivery of the goods. Warranty is excluded for improper use and consequent damages. Warranty is guaranteed only for manufacturing fault.
- Transport costs are always and completely at customer charge.
- Delivery terms are always to be considered as approximate. Shortage of all or part of the goods on delivery can be claimed only if accompanied by written terms agreed upon. Otherwise redraft cannot be claimed.
- All data and technical aspects cited in this catalogue are not binding and may be altered without notice due to technical or manufacturing necessities.
- The invoice referring to the delivered goods is to be paid according to the terms and in the place agreed. Any delay in paying it will enforce late charges.
- In case of disputes, jurisdiction will be the court of Vicenza – Italy.
- This catalogue belongs exclusively to the firm NARDI COMPRESSORI situated in Montecchio Maggiore (VI) Italy; reproduction or copying of the goods without the firm's permission is against the law.

Condizioni generali di vendita (ITALIANO)

- Il presente catalogo annulla e sostituisce il precedente.
- Con il conferimento dell'ordine si considerano accettate tutte le condizioni di vendita.
- La merce si considera franco nostra fabbrica. La merce viaggia sempre a rischio e pericolo dell'acquirente che ha l'obbligo di ritirarla.
- Non si accettano reclami su imballi o spedizioni se non fatti entro 8 giorni dalla consegna della merce.
- I nostri prodotti sono coperti di garanzia per 24 mesi dalla consegna della merce. Non sono garantiti i danni provocati da usura, cattivo uso e non ci assumiamo nessuna responsabilità per danni diretti o indiretti derivanti da tale cattivo uso. La garanzia è valida solo per difetti di fabbricazione.
- Tutti i costi di trasporto sono sempre e completamente a carico del cliente.
- I termini di consegna non sono mai impegnati. La mancata consegna di parte o tutta l'ordinazione non può dar luogo ad alcuna rivalsa di danni verso la nostra ditta, salvo diverse attuazioni scritte e regolarmente accettate.
- Tutti i dati e le indicazioni tecniche citate nel presente catalogo non sono impegnativi e potranno essere modificati in caso di necessità tecniche o produttive, senza alcun preavviso.
- Per pagamenti effettuati oltre la scadenza pattuita saranno addebitati l'interessi moratori al tasso corrente bancario.
- In caso di controversia è riconosciuta la sola competenza del tribunale di Vicenza.
- Questo catalogo è di proprietà esclusiva della ditta Nardi Compressori Srl con sede a Montecchio Maggiore (VI) e senza il consenso della stessa ditta non può essere né copiato, né riprodotto anche solo parzialmente sotto pena delle sanzioni di legge in materia.

This catalogue replaced the previous one

Questo catalogo sostituisce i precedenti

MADE IN ITALY BY NARDI COMPRESSORI

Page 21

Nardi Compressori ITALY

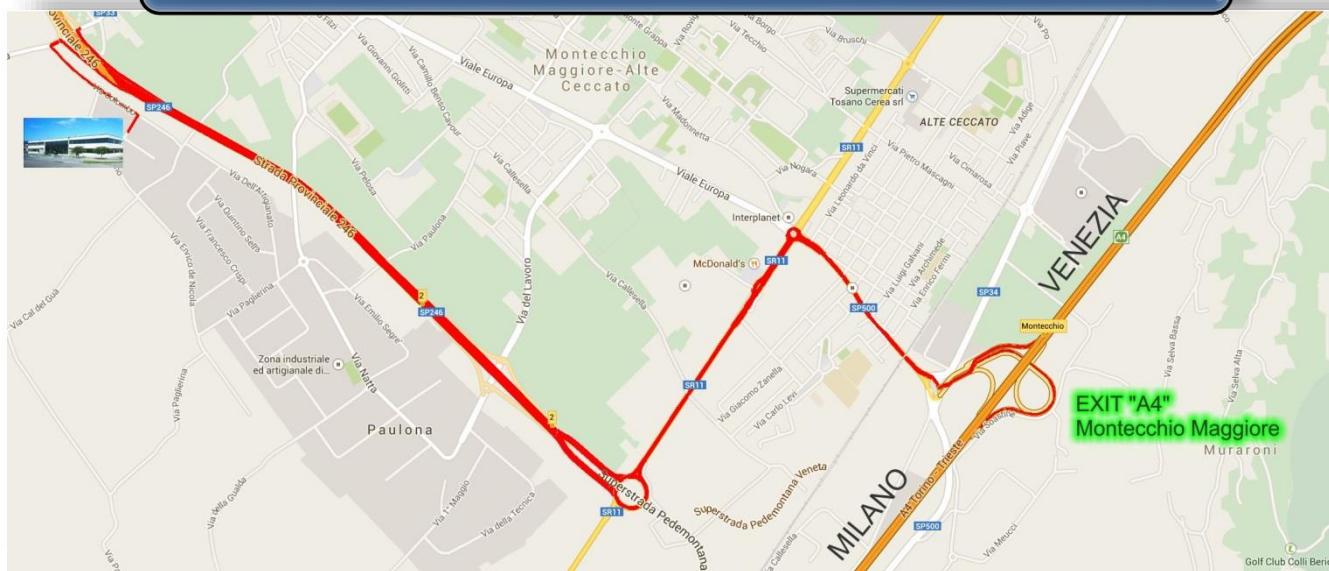

Connection



Railway station **VICENZA** 15 Km



Airport **VERONA** "Villafranca" VRN 55 Km



Airport **VENICE** "Marco Polo" VCE 83 Km



Airport **MILAN** "Orio al Serio" BGY 150 Km



Airport **BOLOGNA** "Marconi" BLQ 170 Km



Airport **MILAN** "Linate" LIN 200 Km



Airport **MILAN** "Malpensa" MXP 230 Km

PRODUCTION

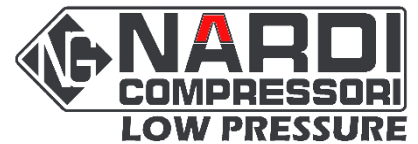

A complete line of oil free low pressure compressors with maximum working pressure of 10 Bar plus a new line of 30 Bar compressors. These compressors have different capacity vessels up to a maximum of 90 liters. Power includes single phase and 3-phase AC electric motors, DC electric motors (battery) as well as internal combustion engines.



High pressure compressors up to 450 Bar for the filling of cylinders for breathing air, used often for scuba diving and by fire stations for fire and rescue operations as well as for military applications.



High pressure compressors and boosters up to 450 Bar. Technical gas compressors with high degree of purity for industrial use, the range is completed by the supply of high pressure cylinders for storage in different capacity and configuration.



High pressure compressors for refueling of vehicles that run on natural gas. Compressors in this line have been designed for industrial and domestic use, creating simple and economic small refueling stations for private use using gas supplied through the network lines.





Nardi Compressori Srl
Via Marco Polo, 2 36075
Montecchio Maggiore (VICENZA) ITALY
Tel. +39.0444.159111 - 497514 -694885
Fax. +39.0444.159122
Mail. info@nardicompressori.com



www.nardicompressori.com



www.facebook.com/nardicompressorisrl/



nardi compressori



+39 340 874 3122

MADE IN VENETO



EXCELLENCE & HIGH TECHNOLOGY